

# WINNERS



**With Winner S  
silence becomes versatile**



**valsir**<sup>®</sup>  
QUALITY FOR PLUMBING



The most versatile  
on the worldwide market

Winner S boasts the most advanced technology on the global market.

It is the lowest flushing system on the market at 800 mm from the finished floor, it is a product with high mechanical performance, high technological innovation, offering an attractive range of plates and a unique soundproof container.

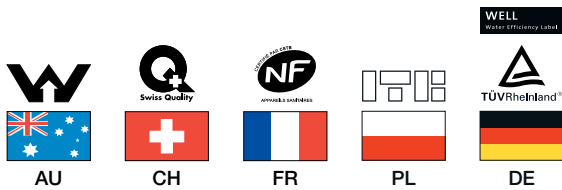

The numerous installation possibilities at different heights, the diverse flush activations, the flexibility in positioning the control plate are the winning features of the innovative Winner S.



Watch the Winner S video  
[valsir.it/u/videowinners](https://valsir.it/u/videowinners)

**MADE IN ITALY**



# FROM THE CORE OUR KNOW-HOW IN SOUNDPROOF SYSTEMS

The experience gained by Valsir with its soundproof waste systems PP3, Triplus® and Silere® has allowed it to reach a level of excellence also with its flush systems, thus adding a very important feature to the numerous advantages of Winner S, that is, silence.

**Winner S, together with Tropea S and Cubik S, are the first cisterns in the world made of a soundproof plastic material.**

Inside the Valsir Research and Development laboratories, a special plastic compound was developed using a unique recipe with the aim of making flush cistern containers soundproofing.



## Silence without compromise also with the internal components

The Winner S internal components have been certified, according to **ISO EN 3822 in silence class I**, both at 3 and at 5 bar, in the prestigious **TÜV LGA Institute in Nuremberg**. The components have also been certified according to the French standard **NF**. The Valsir stop valve in technopolymer is the first on the market to have obtained the NF certification, with tests performed up to 50 bar.

**Winner S, Cubik S and Tropea S are today the only flush cisterns on the market with a certified float valve and stop valve.**







# THE ADVANTAGES OF CHOOSING WINNER S



The material of the container has been designed to ensure an **elevated absorption of acoustic vibrations**.



The materials used for the stop and float valve prevent limescale formation.



The cistern is supplied **100% factory-fitted** to accelerate and simplify installation on site.



**The plate can be** positioned at the **front or above the cistern**, with mechanical, pneumatic or electronic activation.



The rotating inlet fitting **simplifies installation** of the cistern.



The rubber components **are in compliance with EN 681/WC**, ensuring an unrivalled quality and **resistance to chemical agents**.



**The outlet valve**, patented by Valsir, **guarantees the thorough cleansing of any type of pan, even rimless ones**.



With **Winner S**, flush adjustment is simple and the flush **can be set to 6/3 or 4.5/3** fully respecting the protection of environmental resources and Green Principles.



The internal components of Winner S are certified according to **ISO EN 3822**, both at 3 and at 5 bar.



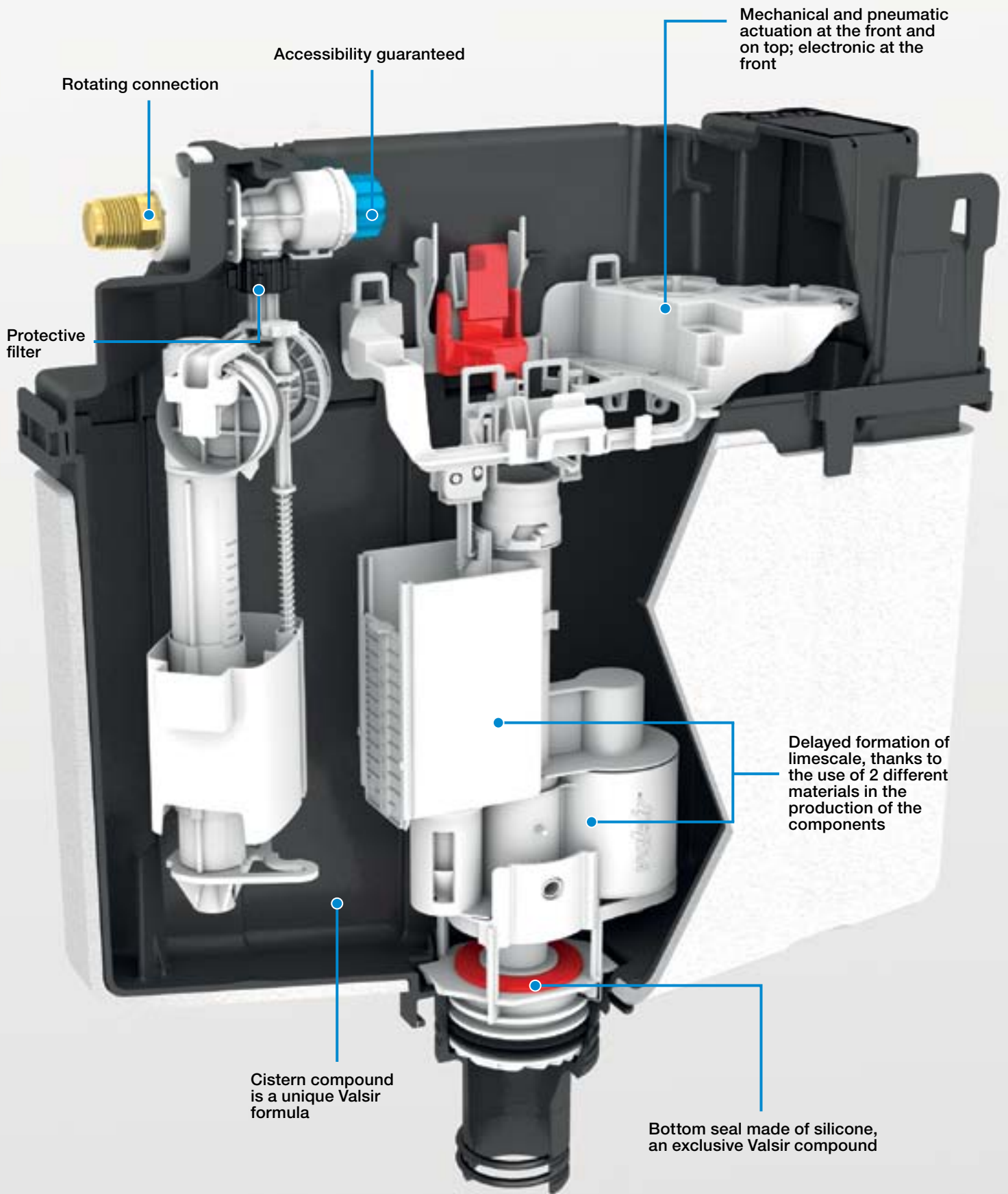

Rotating connection

Accessibility guaranteed

Mechanical and pneumatic actuation at the front and on top; electronic at the front

Protective filter

Delayed formation of limescale, thanks to the use of 2 different materials in the production of the components

Cistern compound is a unique Valsir formula

Bottom seal made of silicone, an exclusive Valsir compound



# THE USUAL OUTSTANDING TECHNOLOGY

## Stop valve

Made entirely of technopolymer and **pre-fitted in the cisterns to facilitate and accelerate installation operations**; the system **incorporates an accessible closing device** to guarantee perfect performance.

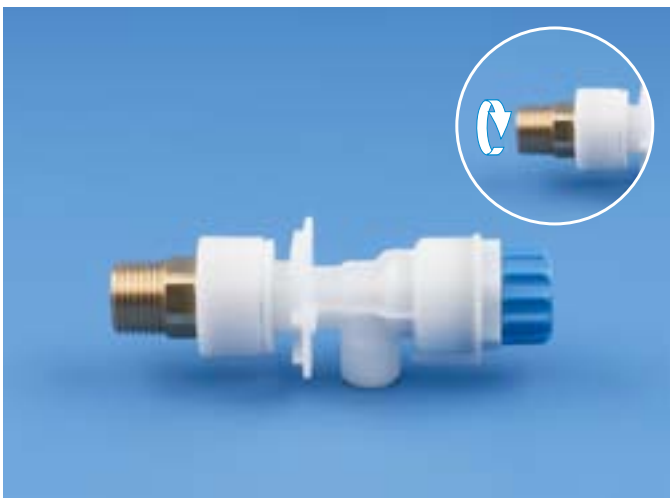

## Compact float valve

Designed and produced to guarantee maximum reliability in all situations, **it resists water hammer as great as 30 bar**. The internal accessible filter and the absence of hose allow for easy maintenance **and guarantee an excellent level of silence**. It is certified in accordance with EN 14124.



## Outlet valve

**The resistance to limescale** of its components, **the self-regulation to the WC pans** present on the market, and the blends of the seals that remain unchanged over time, **make it the most reliable valve on the market**.



## Safety device

**The device guarantees the perfect position and protection of the internal components during handling** of the cistern until the control plate has been installed.



# WINNER S, THE MOST VERSATILE

Three heights, on possibility of positioning the plate at the front or top and the choice of activations guarantee maximum installation flexibility on site.

The available range, masonry, Fixsystem, Block and free-standing Block, makes it perfect for all system requirements, regardless of the wall type.

## Winner S in masonry walls H 800 - H 880 - H 1140

The ideal solution for installations where height is limited, for example in areas under the window: thanks to its minimum installation height equal to 800 mm from the finished floor.

Available in three heights: 800 mm, 880 mm and 1140 mm.



## Winner S Fixsystem H 800 - H 880 - H 1050

Winner S Fixsystem is the cistern **with frame for wall-hung pans to be installed in brick walls.** Winner S allows the installation of a wall-hung pan starting from a reduced height of 800 mm from the finished floor, to a height of 880 and 1050 mm.

The frame is supplied with all the accessories necessary for installation.



## Winner S Block H 800 - H 880 - H 1140

**Winner S Block is used for the installation of wall-hung pans in light walls, such as plasterboard and wood.** The frame is painted to prevent corrosion and complies with the static resistance of 400 kg according to EN 997.

**The frame is available in 3 different heights: 800 mm, 880 mm and 1140 mm.**

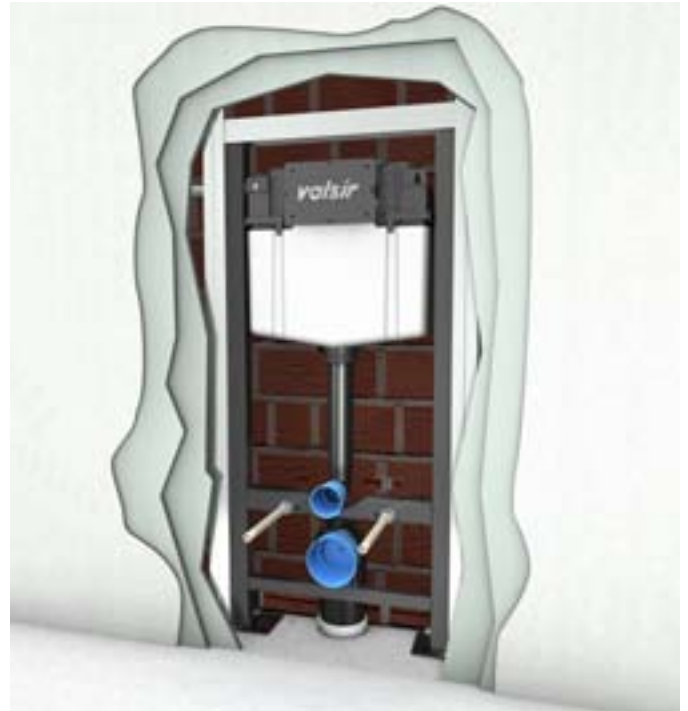

## Free-standing Winner S Block H 800 - H 880 - H 1140

**Free-standing Winner S is used for installations of wall-hung pans when there are no load-bearing walls for anchoring the frame.** The frame is anchored to the floor only and complies with static resistance of 400 kg according to EN 997.

**The frame is available in 3 different heights, 800 mm, 880 mm and 1140 mm and is available with the choice of mechanical, pneumatic and electronic activation to best suit system requirements.**

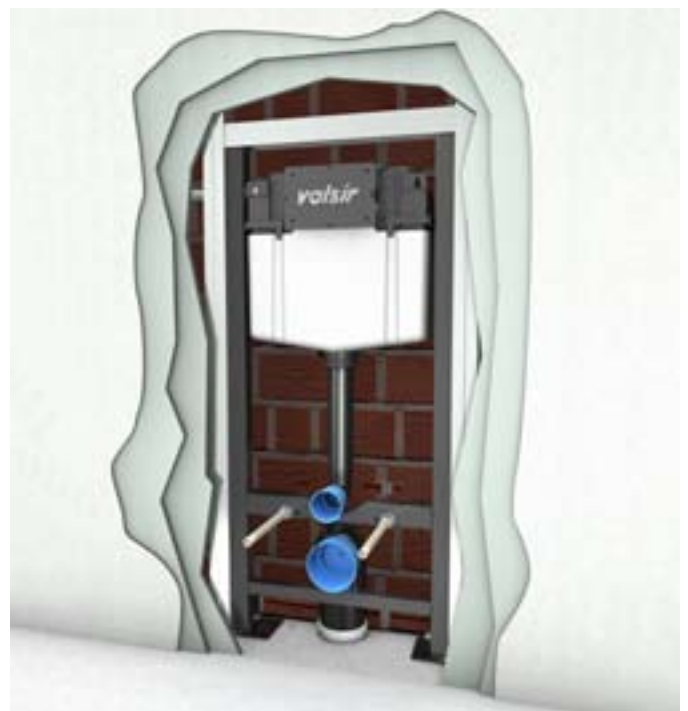



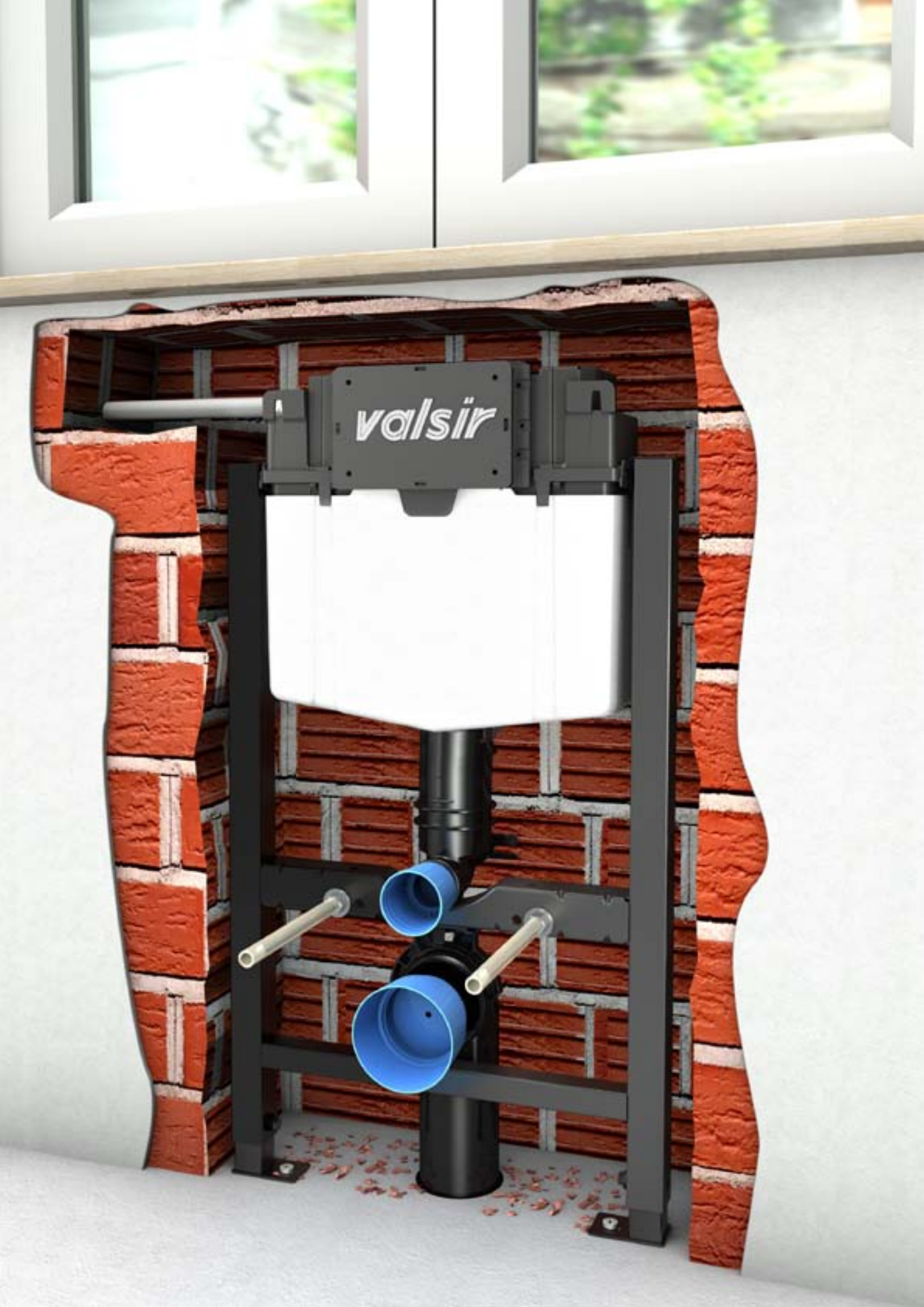

# THE MULTIPLE SOLUTIONS OF WINNER S

Thanks to an accurate study and the wide flexibility of the solutions proposed, **Winner S** has allowed the installation limits related to the old technologies on the market to be overcome.

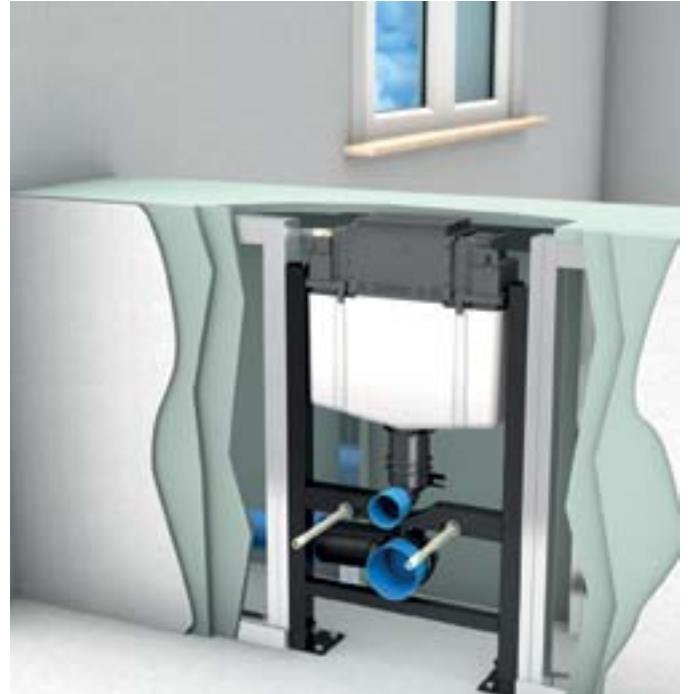

## The Fixsystem template make it easy

To enable a rapid and simple installation of the Fixsystem frames, **we have designed an installation template that is very practical and drastically reduces installation time.**

This accessory was designed to provide an installation support during the installation phases of the Winner S and Tropea S Fixsystem frames to the wall. In this way the job can be done by only one person guaranteeing the best result.



Watch the Winner S video  
[valsir.it/u/vidiodimafix](https://valsir.it/u/vidiodimafix)





# ARIAPUR, THE ODOUR AND VAPOUR EXTRACTOR FAN

Ariapur is an extractor fan that performs a dual extraction function, thus ensuring the perfect renewal of air inside the bathroom.

**Ariapur extracts air both through the wall or ceiling extraction grid and through the WC pan as it is connected to the flush pipe.**

Its capacity to eliminate odours before they spread to the room **makes it the most effective and innovative extractor fan on the market.**



Watch the Ariapur video  
[valsir.it/u/videoariapur](https://valsir.it/u/videoariapur)

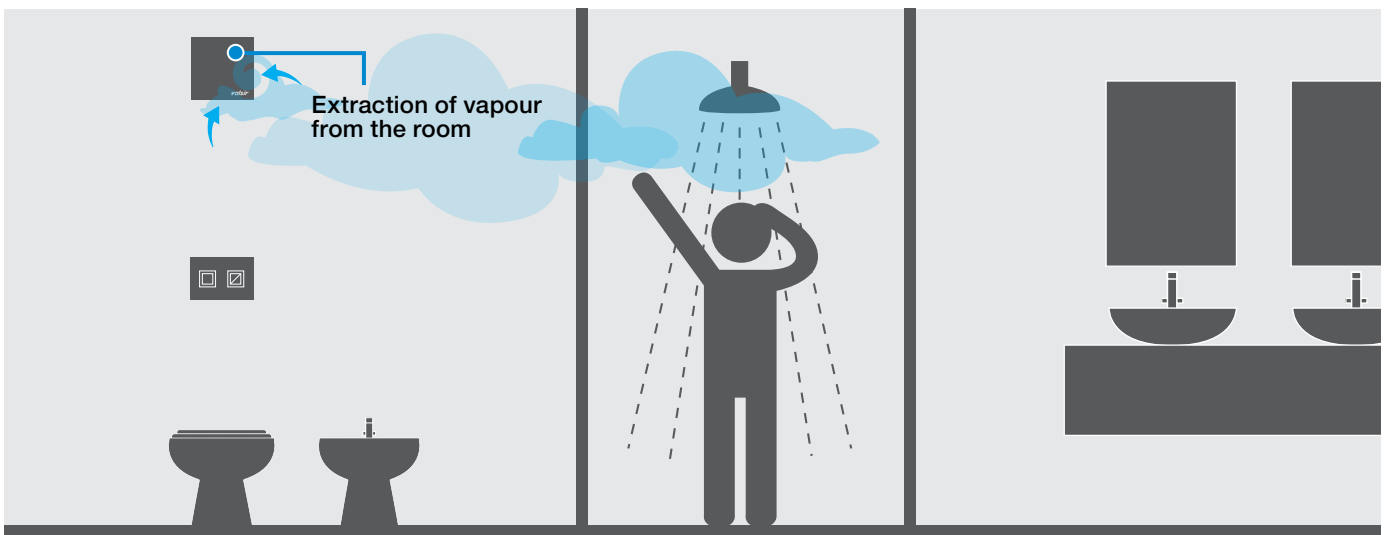
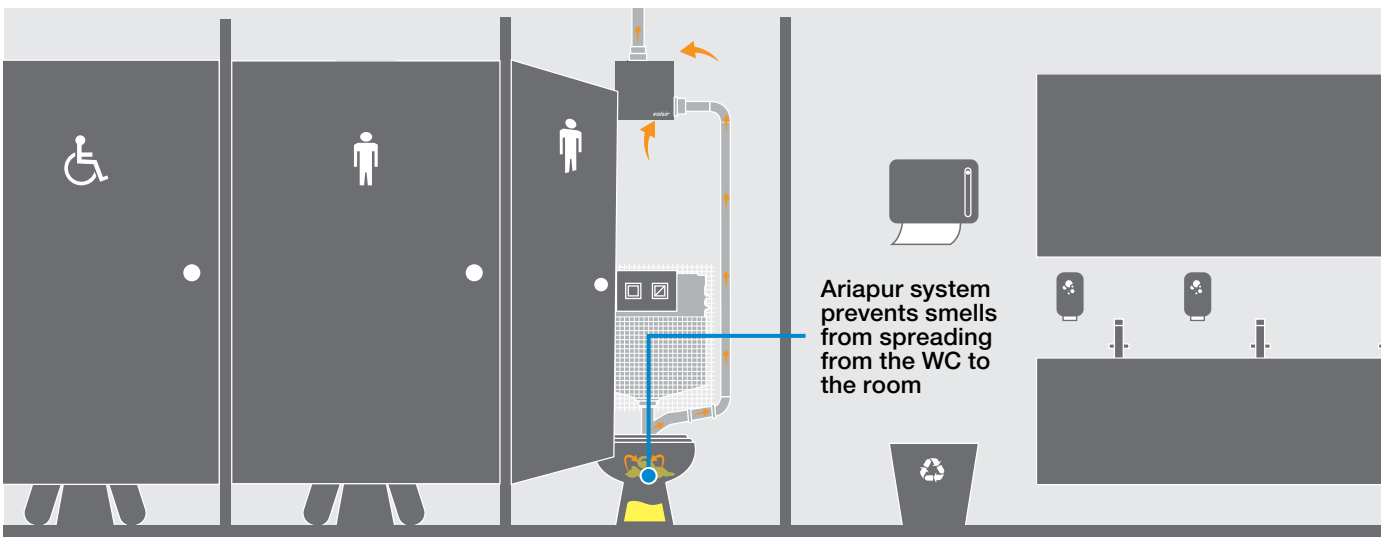
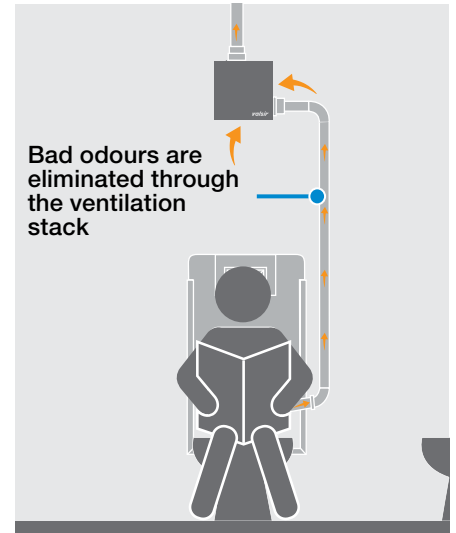
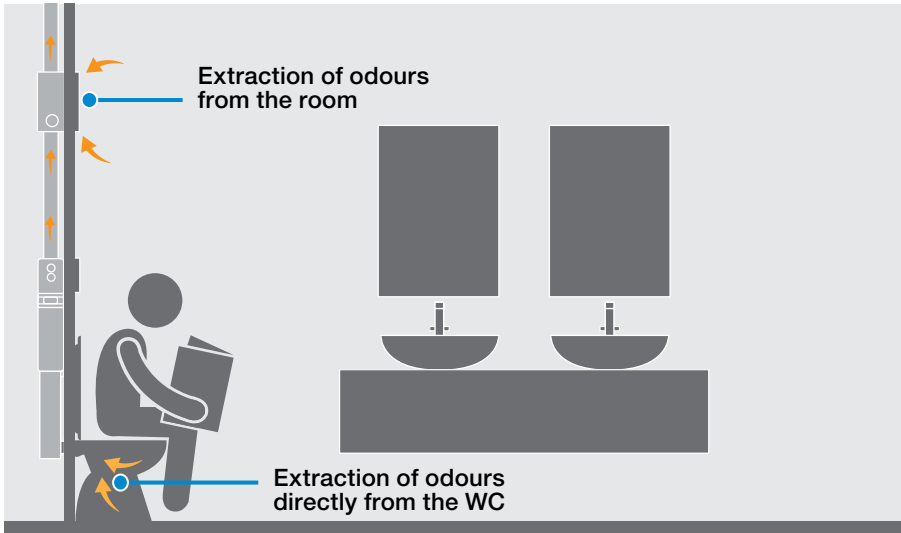

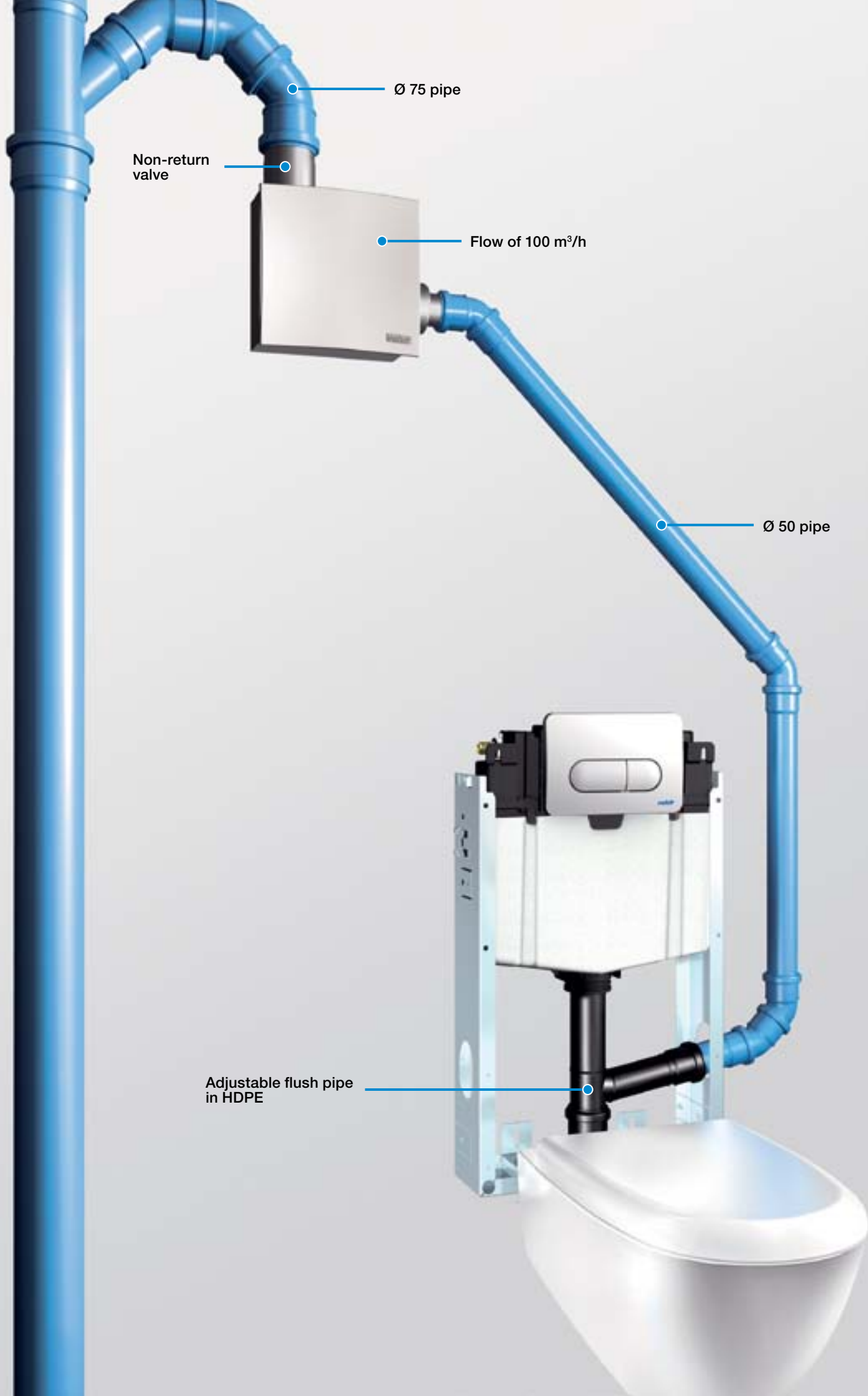

Ø 75 pipe

Non-return valve

Flow of 100 m<sup>3</sup>/h

Ø 50 pipe

Adjustable flush pipe in HDPE

# THE GUARANTEE OF THE PERFECT AIR EXCHANGE

## Non-return valve

The valve, positioned on the outlet side, **prevents the return of odours** generated inside the stack. Thanks to the non-return device, **Ariapur does not require its own stack** but can be connected directly to the ventilation stack of the waste system.



## Connection flexibility

The adjustable flush pipe allows obstacles in the installation phase to be overcome. **The connection can be positioned to the right or left** and it is equipped with a push-fit socket joint.



## Also for thin walls

By using the special frame, **Ariapur can be installed in walls of just 80 mm**. If installed without the frame, the minimum thickness is 100 mm. Ariapur can be painted and fits in discreetly in any bathroom.



## Choice of activation

Ariapur can be electrically activated. Activation can be chosen from: traditional switches and presence detectors. It incorporates an internal **timer to guarantee the correct renewal of air**.









# CONTROL PLATES: FURNISH WITH STYLE

Today, the control plate is no longer just an element required to activate the flush cistern, but inside the bathroom it has acquired an important aesthetic value, thus truly becoming an object of design.

Winner S offers **a multitude of choices with new solutions that are combined with classical materials such as metal or plastic materials.**

The latest trends range from stainless steel to tempered glass; from new materials such as black and white DuPont™ Corian® or anodized aluminium, to the innovative installation methods, **such as the surface-even plate and the be spoke kit.**

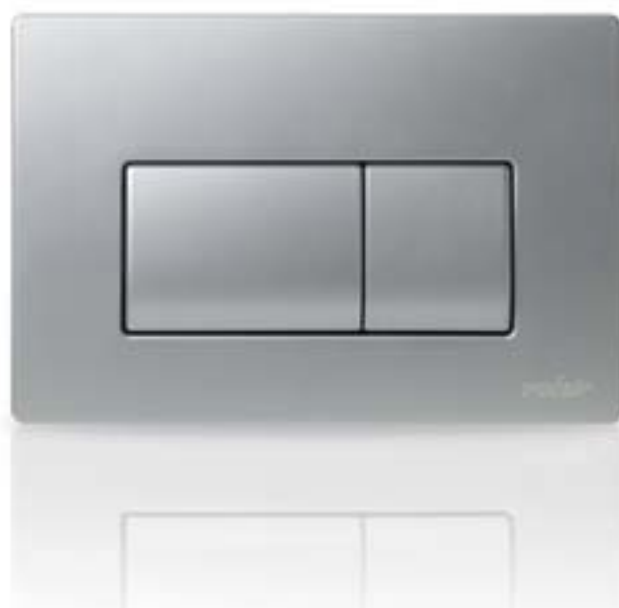
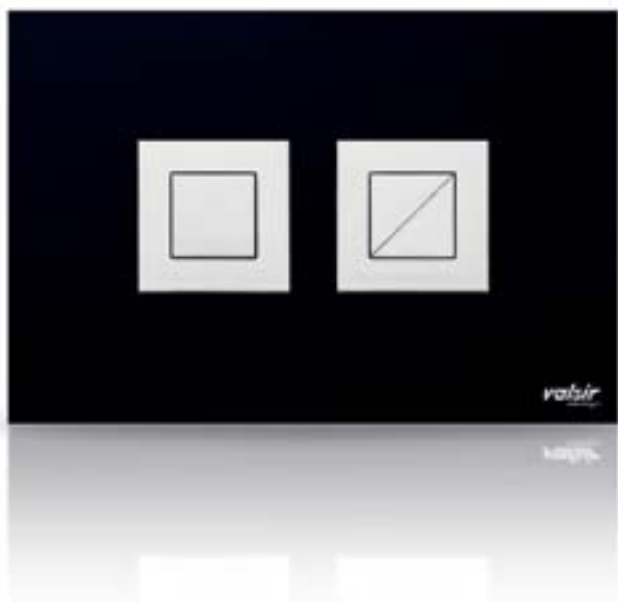



# VALSIR DESIGN PLATES

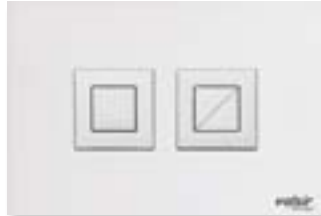

Over 35 models with 250 possible combinations, the control plates are created using innovative and elegant materials that allow all bathrooms to be customized with a touch of style.

The refined transparency of the Crystal line, the essential elegance of stainless steel, the creativity of the Fantasy line and the solidity of wood and stone of the Wood and Stone line using the new materials such as anodized aluminium and DuPont™ Corian® find space in a new environment: the bathroom.

All the Valsir Design plates incorporate buttons made with different finishes, characterised by soft actuation, silence and precision.

## Be spoke kit

The customizaion kit allows the creation of an actuation plate with the materials used to furnish the bathroom.

The kit is composed of a template for cutting, a frame in stainless steel and round or square and polished or satin activation buttons.

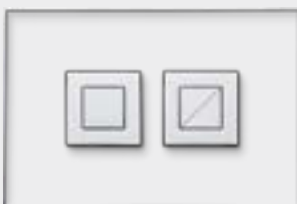

Customized plate kit, polished chrome



Customized plate kit, satin chrome



# FEEL, THE SURFACE-EVEN PLATE

Valsir has developed a system that allows the easy installation of the plate inside the wall. Installation is simple, the job is flawless and the result is perfect!

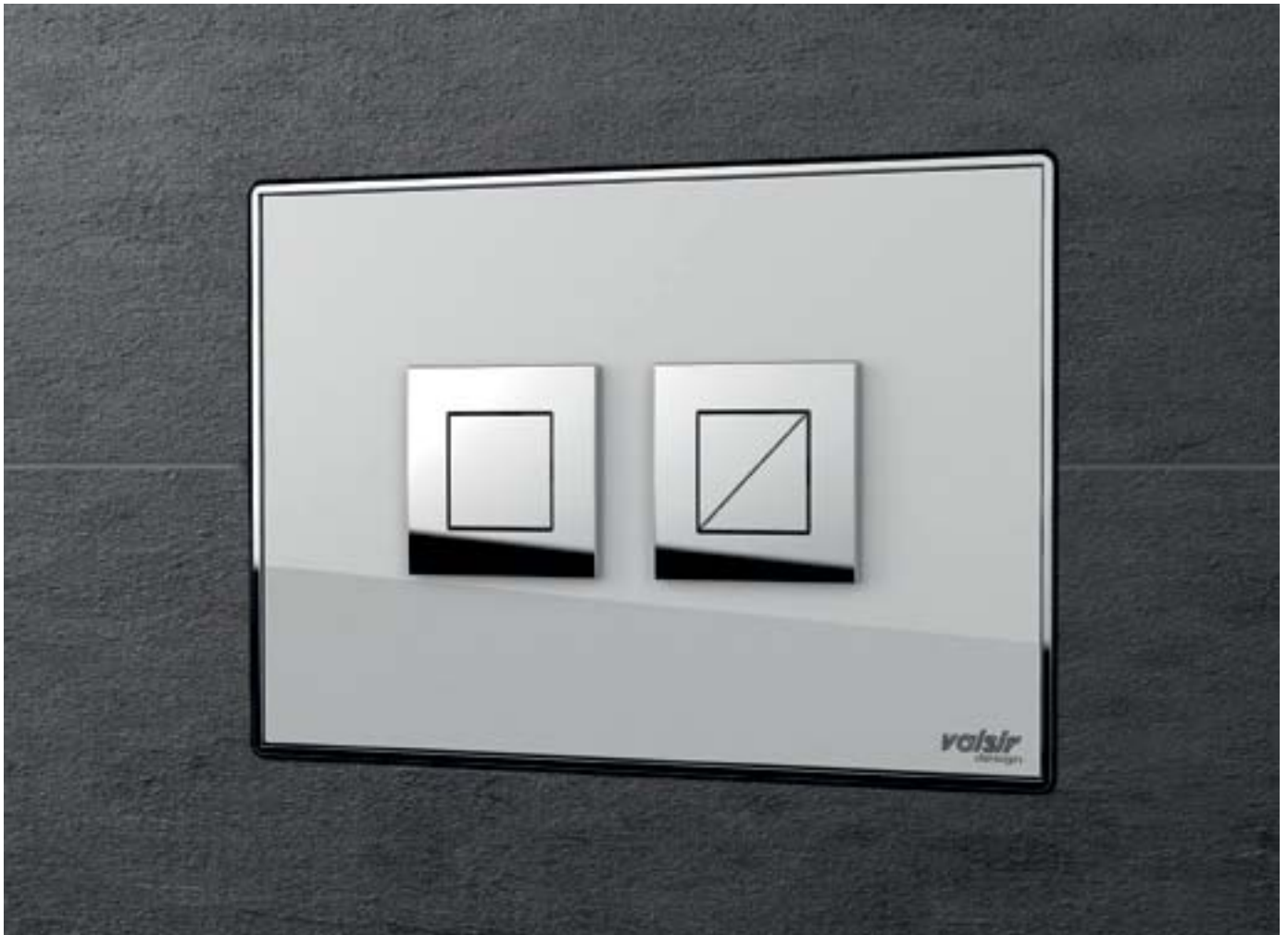

# PLATES



**P1** - 215x145 mm  
 Finishes: white - polished  
 chrome satin chrome



**P2** - 215x145 mm  
 Finishes: white - polished  
 chrome satin chrome



**P3** - 215x145 mm  
 Finishes: white - polished  
 chrome satin chrome



**P4** - 215x145 mm  
 Finishes: white - polished  
 chrome satin chrome



**P5** - 215x145 mm  
 Finishes: white - polished  
 chrome satin chrome - white  
 and gold



**P6** - 245x165 mm  
 Finishes: zama polished chrome  
 zama satin chrome



**P7** - 215x145 mm  
 Finishes: polished inox - satin  
 inox

## The P5 plate gets a new look

The P5 plate allows maximum customization creating unique combinations of buttons and masks with various finishes: white, polished chrome, satin chrome and gold.

Customized finishes can also be requested.







# INFRAROSSA AND REMOTE CONTROLS

The “Infrarossa” electronic control plates, made of robust chrome metals **are the ideal solution in public and commercial locations**, such as hospitals, airports, and shopping centres and in bathrooms for those with disabilities.

**They also incorporate a vandal-proof system** to guarantee maximum safety and inaccessibility.

By means of the plates in the Infrarossa range, the flushing system is activated automatically, ensuring hygiene and functionality in all situations.

**The plates also provide an automatic flush every 24 hours.** In this way, cleansing of the pan and total hygiene are guaranteed.

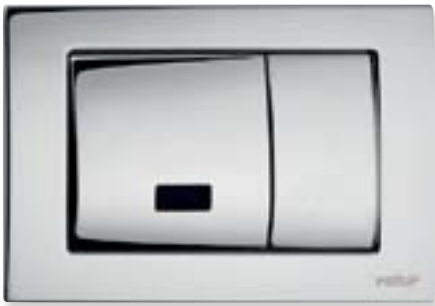

**Dual** - 245x165 mm  
Finishes: polished chrome



**Eye** - 245x165 mm  
Finishes: polished chrome

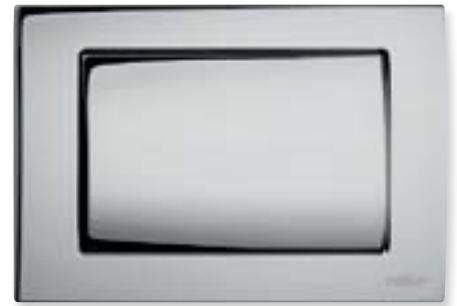

**Remote** - 245x165 mm  
Finishes: polished chrome

Pneumatic activation is achieved by means of wall buttons (R line) and floor buttons (FOOT) made of steel or plastic.

**The R line** allows single activations with a dual flush both level with the wall or with a protrusion. Ease and activation smoothness are always guaranteed, ensuring installation flexibility with distances between the button and the cistern of up to 2.5 m.



**FOOT1** - 120x120 mm  
Finishes: polished inox



**FOOT2** - 110x160 mm  
Finishes: polished inox



**R1** - Ø 105 mm  
Finishes: white - polished  
chrome - satin chrome



**R7** - 175x100/155x85 mm  
Finishes: polished chrome -  
satin chrome

# FACILITATED ACTIVATION PLATES

The range of pneumatically operated buttons is made complete with the facilitated activation plates.

Designed for bathrooms for the disabled, the pneumatically operated buttons were created specifically to make actuation easier: the pressure required for activation is reduced and they are also available in the protruding version.

For the partially sighted, buttons were created with chromatic differences between the full and partial flush. In this way, the difference is more visible.



R3



R4



R5



R6



# SECURITY, TAMPER RESISTANT PUSH BUTTON



Created to meet the requirements of installations in thick walls, the security button was designed according to a concept of total safety and inalterability, which make it the ideal solution for vandal and tamper resistant applications.

- Installation in thick walls (max. 400 mm).
- Servicing guaranteed by the total accessibility of the system.
- Easy to install and adjust.
- Installation requires a hole of just 42 mm in diameter.
- Vandal resistant.
- Ideal solution for clinics, stadiums and prisons.

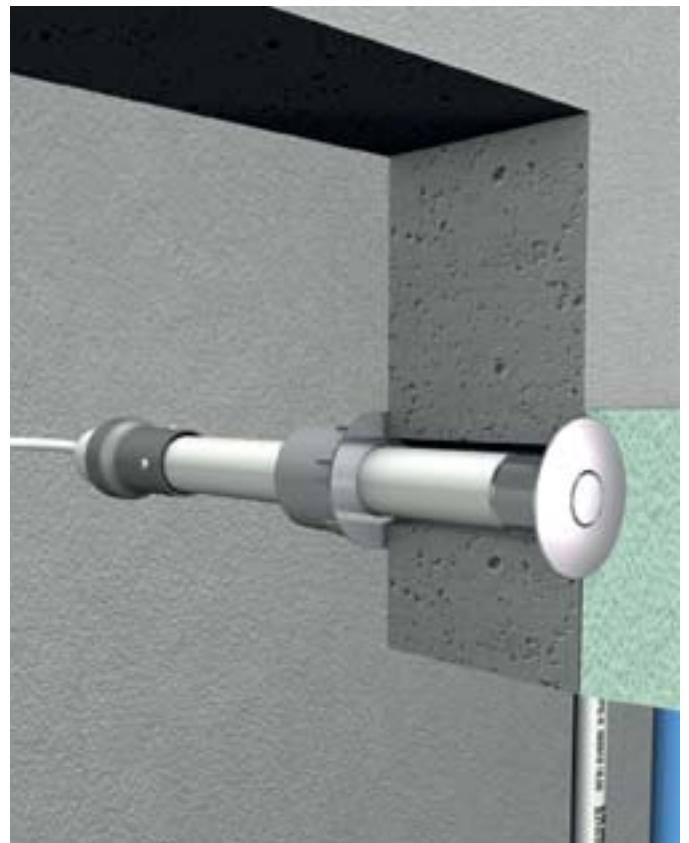





# CUSTOMER SERVICE

## Technical support

Valsir provides complete support during design and on site, thanks to a high-level technical department that consists of a team of engineers with international experience that are capable of providing solutions to all installation needs.



## Valsir Academy

Valsir has an important training facility - **Valsir Academy** - dedicated to clients, distributors, plumbers and planners that provides perfectly equipped courses, theoretical and practical courses on the use and the design of plumbing and heating systems. Courses are provided both inside the training facility and on customers' premises.

# SOFTWARE

## Silvestro software

The design of floor and radiator heating systems, water supply as well as waste and drainage systems, is extremely easy and the issue of the project technical documents is rapid when using the Silvestro software program. Rapid, simple, unique, Silvestro has numerous strong points:

- rapid learning curve thanks to a simple and intuitive interface
- completely graphic background that facilitates input of the project details
- automatic drawing of the loops in the floor radiant systems
- automatic repositioning of the stack points on the plan view
- generation of calculation reports that are exportable in an .xls format
- import and export of files in .dwg format
- immediate update of software with a guided procedure
- creation of complete bill of materials from the project files

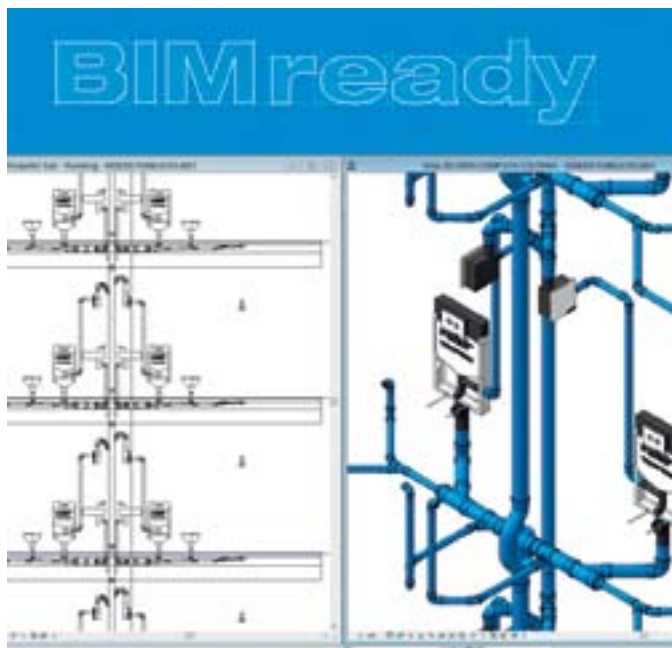

## Valsir is BIM ready

Valsir has embraced the BIM philosophy, the modelling process that allows the improvement of planning, design, construction and the management of buildings, concurring with the transition of the industry toward the digital representation of buildings. “BIM oriented” planning offers extraordinary competitive advantages: greater efficiency and productivity, less errors, less downtime, lower costs, enhanced interoperability, maximum sharing of information, a more punctual and coherent supervision of the project. Valsir captures the essence of this system creating a series of Revit applications and models designed for simple and fast use.

# QUALITY AND ENVIRONMENT

## Quality

The constant commitment of Valsir to the creation of quality products is demonstrated by over 170 product approvals obtained around the world from the most strict certification bodies (figure updated on 01/02/2017), and by a quality system that is certified to **UNI EN ISO 9001:2008**.



## Sustainability

Efficient processes and reliable products are no longer the only parameters used to perform an assessment of the quality of a company's conduct: the capacity of the company and its management to design and implement production process that are sustainable from an environmental point of view is of equal importance.

Valsir has started a project of Corporate Social Responsibility and has published its 1<sup>st</sup> Sustainability Report that gathers facts and figures relating to the daily commitment of Valsir in terms of social, economic and environmental responsibility.

For more information, download here the 1<sup>st</sup> Sustainability Report.

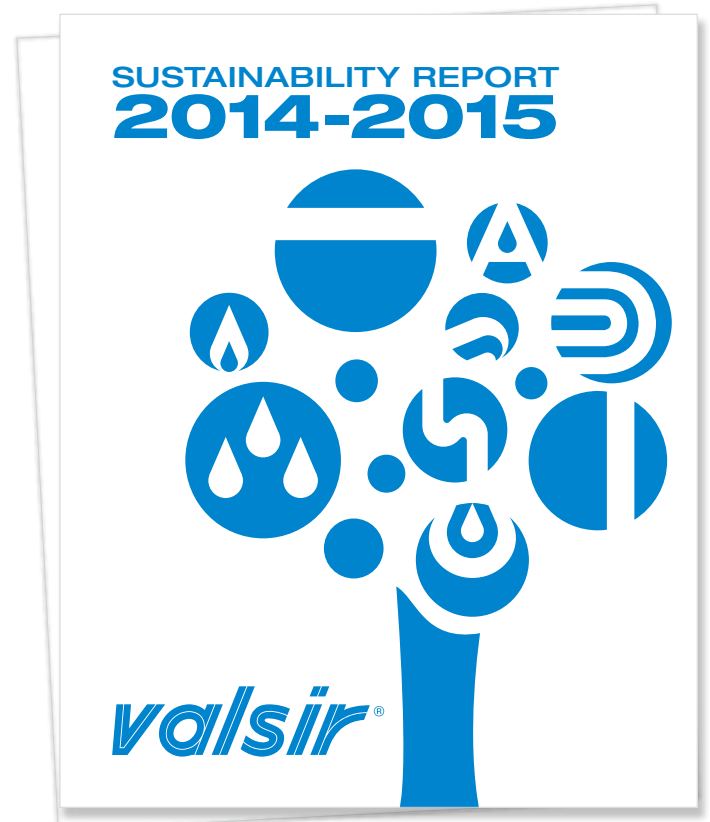

Download  
[valsir.it/u/sostenibilita-en](http://valsir.it/u/sostenibilita-en)



PLUMBING

WASTE SYSTEMS



SUPPLY SYSTEMS



GAS SYSTEMS



FLUSH SYSTEMS



BATHROOM SYSTEMS



TRAPS



RADIANT SYSTEMS



DRAINAGE SYSTEMS



HRV SYSTEM



ACADEMY



SEWER SYSTEMS



WATER TREATMENT



BUILDING

**valsir**<sup>®</sup>  
QUALITY FOR PLUMBING

**VALSIR S.p.A.**  
Località Merlaro, 2  
25078 Vestone (BS) - Italy  
Tel. +39 0365 877.011  
Fax +39 0365 81.268  
e-mail: valsir@valsir.it

**www.valsir.it**

Soggetta all'attività di direzione e coordinamento ex art. 2497 bis C.C. da parte di Fondital Group S.p.A. - Codice Fiscale 02075160172

L02-799/0 - Febbraio 2017

